



# BT TV user guide

# Welcome to BT TV

Over the next few pages you'll find everything you need to get your BT TV service/box up and running.

---

**2** **Getting started**  
Let's set up your BT TV box.

---

**4** **Let's get going**  
How to use your remote and set up your parental controls and payment PINs.

---

**7** **Get the most out of your TV**  
You'll be box-set binging in no time, with our on-demand players and up to 300 hours of recording space.

---

**10** **What your box lights mean**  
Understand the status of your BT TV box.

---

**11** **Need some help?**  
We're here to help with any questions you have about BT TV.

---

**12** **Accessibility**  
Make BT TV even easier to use with things like audio description and subtitles.

# Getting started

**Before you set up your BT TV box, make sure your broadband is up and running.**

Once you're connected to the internet, you can get started with these simple steps. Or if you prefer, watch our set-up video at [bt.com/help/tvinstall](https://bt.com/help/tvinstall)

# 1

## Plug in

Plug your aerial and HDMI cables into the right places (see the page opposite).

# 2

## Get online

Connect your hub to your BT TV box using the Ethernet cable.

# 3

## Power up

Plug your BT TV box into the nearest socket on the wall.

Press the power button on the top of the box to turn it on, and follow the on-screen steps. (When asked, we suggest you choose 'Smart standby' for faster start-up).

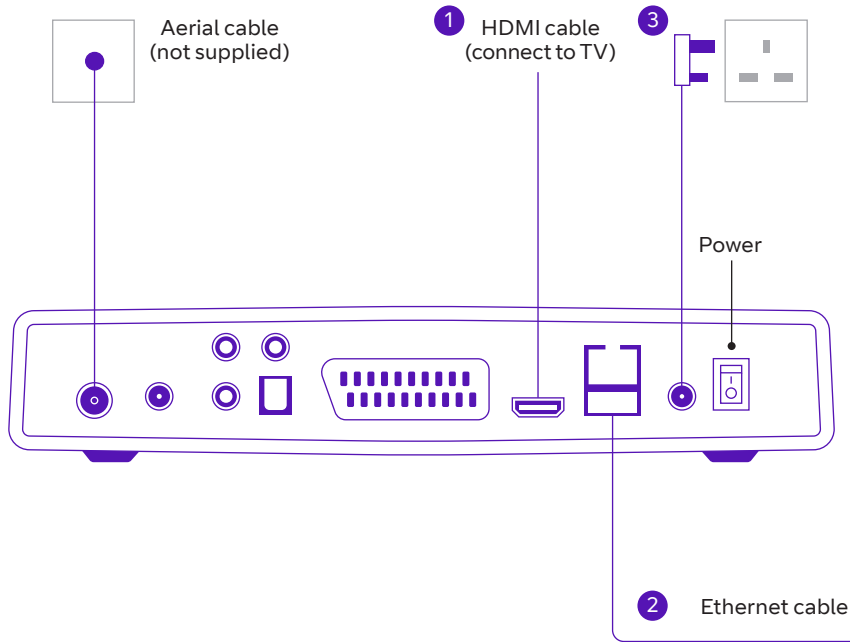

### Connect broadband first

Make sure you're connected to the internet before setting up your TV box.

### Hub and TV box in different rooms?

If the Ethernet cable won't reach, you can use Mini Connectors to connect your Hub and TV box.

Visit [bt.com/help/miniconnectors](https://bt.com/help/miniconnectors)

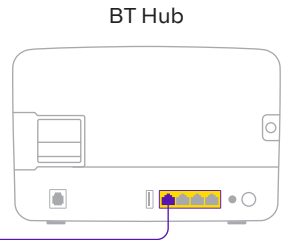

# Your remote

## On/off



TV



TV AV

TV AV

## TV AV input

Use this to switch between your AV devices (like a games console).

## Home



Brings up the preview bar, on-demand programmes, players, apps, recordings and settings.

BT Player



BT Player

## BT Player

A huge library of on-demand entertainment.

## Information



For more information about a TV programme.



## Pause

Pause, rewind and fast forward whatever you're watching, including live TV.

## Record



Record a one-off programme or a whole series.



Search

## Search

Search for content across all TV and on-demand players.

## TV guide



See what's on TV and radio for the next 7 days.

Guide

Search

Close

Delete SUB

## Delete/Subtitle

Delete a recording or turn subtitles on/off.

# Use your BT TV remote to control everything

## Use one remote instead of two

- 1 Turn on your TV, then look up the four-digit code for your brand of TV (see the table on the right). Then hold down **ⓄTV** and **TVAV** until the blue light on the remote flashes three times.
- 2 When the flashing stops, enter your **TV brand code**. The blue light will flash another three times.
- 3 Hold down **ⓄTV** until your TV turns off. The blue light will blink while it turns off.

- 4 When your TV turns off, let go of **ⓄTV** and press it again – your TV should turn back on. Next try Vol **+**, Vol **-**.

For some TV brands, you need to press **OK** instead of **ⓄTV**. So if it's not working, try this step again but press **OK**.

- 5 If the volume control works, press **OK**. And that's it!

If it doesn't work, start again from step 3.

## TV brand codes

<b>Goodmans</b>	2037	<b>Philips</b>	3951
<b>Hitachi</b>	2424	<b>Samsung</b>	4483
<b>JVC</b>	2788	<b>Sharp</b>	4848
<b>LG</b>	2992	<b>Sony</b>	4985
<b>Panasonic</b>	3846	<b>Toshiba</b>	5523

If your make of TV isn't listed here, you can find a full list of brands and codes at [bt.com/help/remote](http://bt.com/help/remote)

# Parental control and payment PINs

Take control over what your kids stumble across (and rent!) by setting up parental controls

## About your PINs

There are two PINs: one for parental controls and one for payments.

Use your **parental control PIN** to control access to programmes with an age rating.

The default PIN is 1234.

You can change it at any time. Just go to Settings, then Change Parental Control PIN.

If you forget your Parental Control PIN, you'll need to reset the box.

**Go to [bt.com/help/resettv](https://bt.com/help/resettv)**

Use your **payment PIN** to buy things on the BT Player.

You can have the same PIN for both if you like.

If you forget your Payment PIN, call us on **0800 111 4567** or go to **[bt.com/PIN](https://bt.com/PIN)**

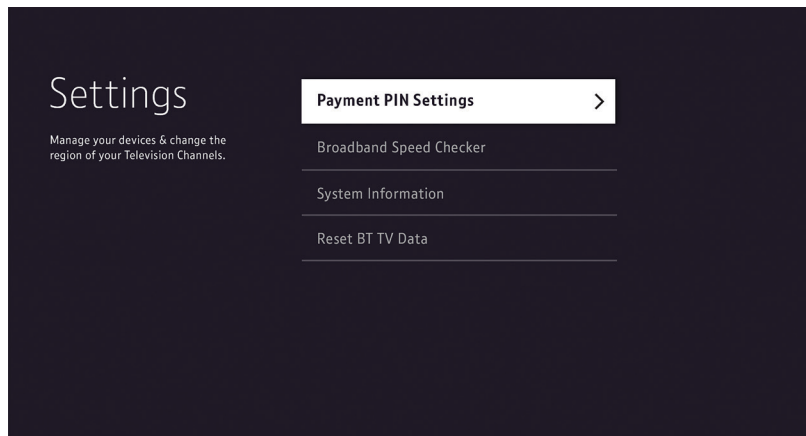

# Watching and recording TV

Your box comes with up to 300 hours of recording space.

Press **R** to record something you're watching live (it'll record from the time you press the button).

## Recording two programmes

If you record two programmes at the same time, you can't then watch a third on live TV.

You can watch something else on a streaming service like Netflix or NowTV, or a programme you've already recorded.

## Watching Live TV

You can find all of the Freeview channels from 001 to 250 and your BT subscribed channels from 300 to 550.

To make it easier to find the channel you're after, you can press **0** to access the channels categories, when in the guide.

## Watching your recordings

Press **+** and go to MyTV

Highlight the programme you want to watch and press **OK** or **▶**.

## Auto-deleting recordings

If your BT TV box is full of recordings, it'll automatically delete the oldest one you've watched.

Good news, though. You can save an old recording from being deleted automatically by locking it. Just highlight the recording and press **0**.

To unlock it, highlight it and press **0** again.



# On-demand

There's loads of on-demand content available within the 'Players' section.

The BT Player is the place to go to watch, buy or rent the latest blockbuster movies and most talked about TV shows.

Press  and choose Players & Apps.

To return to live TV at any time, press .

With on-demand services you can watch what you like, whenever you like.

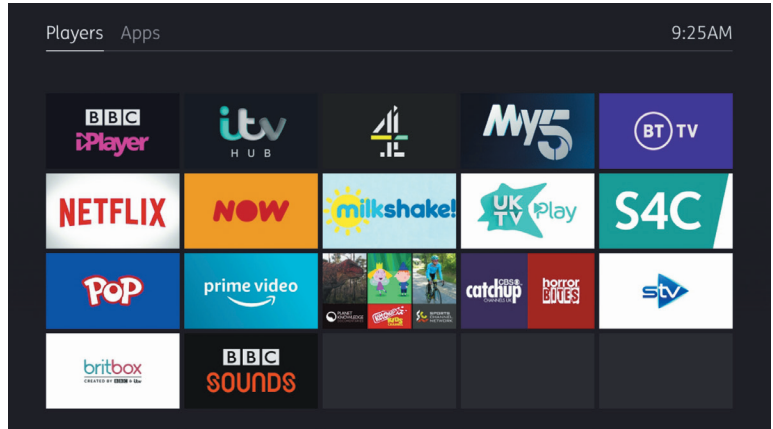

\*Britbox Player coming soon

# The BT TV app

Watch the latest episode of your BT TV content (doesn't include Freeview content) wherever you are, using the BT TV app.

You can start watching something on your TV, stop it, and pick up where you left off on your mobile or tablet. We call that our **Continue Watching** feature.

Here's what else you can do with the app:

- Watch all your live BT TV subscription channels
- Watch your BT TV shows via on-demand catch up
- Download films and TV that you've bought to watch offline

## Who can use the BT TV app?

If you've got BT TV, you're in. Just download the app and log in with your BT ID and password.

## Recording on the move

If you've gone out and forgotten to record something, all is not lost.

You can start a recording remotely through the BT TV app.



# What your BT TV box lights mean

The lights on the front of your box show you what it's doing.

## Box status

---

Box in standby (Energy Saver)



---

Box in standby (Always Ready)



---

Box on, connected to hub



---

Box on, recording



---

Box in Standby, recording  
(Energy Saver)



---

Box in Standby, recording  
(Always Ready)



# Need some help?

If you need any help, **bt.com/help/tv** is a good place to go. We've got loads of FAQs to help answer any common questions, and other tips with getting the most out of your service.

Or you can chat with us online (any time between 7am and 11pm) at **bt.com/chat**



You can speak to us on the phone too. Just call 0800 111 4567 anytime between 8am and 9pm (we're usually less busy between 12pm and 6.30pm).

# Accessibility tools

To review and change your accessibility settings, press  then select **Settings** and scroll down to **Accessibility and Language**.

Here's a summary of what's what.

## Turn on Subtitles, Audio Description (AD) and Sign Language

If the broadcaster provides these features, they're available on live TV, on-demand programmes and your recordings. On your remote, use   and  to turn Subtitles and Audio Description on and off.

## Make your remote beep when you press a button

If you're not sure if you've pressed a key or not, turn on **Audio feedback** so there's a beep on the TV every time you press a key on the remote. Partially sighted and blind viewers might find it makes navigation easier.

## Menus difficult to read?

### Switch on the high-contrast colour scheme

If you find the menus difficult to read, there's a high-contrast colour scheme you can use instead. It has white text on black and the menu options don't blend in with the background.

### Remove channel logos

You can stop these logos appearing in the **Guide** to make it easier to read.

### Remove transparency

You can change settings so that you don't see the 'transparent' background image of a programme while you're browsing the **Guide**.

## Using Zoom

The **Zoom** button has two functions: one for the main menu and one for the Guide (where you find live TV channels).

### How to zoom when using the main menu

If you're finding it difficult to read some of the text while you're in the main menu or sub-menus (such as **Settings**), you can use **Zoom** to make it bigger.

For example: press **Home** to bring up your main menu, then press **Zoom** to make the text bigger (you'll be able to use the options on the screen as usual). Press **Zoom** again and you can use the arrow buttons to move around the screen. Press **OK** to be able to use the options again. Press **Zoom** for the third time to go back to the normal view.

### How to zoom when you're using the Guide

Press **Guide**. When you can see the TV listings, press **Zoom** to make the text bigger (you'll be able to use the options on the screen as usual). Press **Zoom** again and you can use the arrow buttons to move around the screen. Press **Zoom** again to return the text to its original size.

### Grid 3 Software

Software available for Windows PC's and tablets. You can use it to control your BT TV box without a remote or keyboard. It allows you to control with touch, switch, eye gaze and pointing devices.

You can find out more about this at [btplc.com/inclusion/bttv](http://btplc.com/inclusion/bttv) and [thinksmartbox.com](http://thinksmartbox.com)

## Using your keyboard as a remote

You can use a UK USB keyboard to interact with your BT TV box, either alongside the remote or instead of it. There's a USB connection on the back left-hand side of the box.

- This option supports USB keyboards.
- Certain keys imitate the buttons on the remote.
- You can use the standard alphabet keys to enter text.
- The '1' key also cycles through punctuation.
- The keyboard number keys work in just the same way as the number keys on the remote.

Your BT TV box supports a number of keyboard layouts including Jumbo, Clevy, and multimedia. Read more about this and print out keyboard overlays at [btplc.com/inclusion/bttv](http://btplc.com/inclusion/bttv)

# Safety and legal information

Your BT TV box (Model DTR-T2100) from BT is manufactured to comply with international safety standards. Please read the following instructions carefully before installing and using it. Keep these instructions safe for future reference.

## Power supply unit (adaptor)

To avoid risk of electric shock or fire, you must only use the power supply adaptor provided.

Connect the appliance to the mains following the information on the label of the appliance and on the power supply adaptor.

Never connect your appliance to a socket that has come loose or is damaged or defective (risk of electrical shock and fire).

## Children and pets

Make sure that the power supply adaptor and the remote control are out of reach of children or pets.

## Batteries

The batteries must not be exposed to excessive heat such as the sun, a fire or similar sources.

It is required to replace the primary (non-rechargeable) batteries supplied only with strictly equivalent types (voltage, chemistry, size).

## Liquid

Keep all liquids at a safe distance from your TV box and power adaptor.

Keep them away from damp areas and sources of water.

Don't put anything filled with liquid on top of it (like a vase of flowers).

If liquid does enter the TV box, unplug it immediately from the mains taking all necessary precautions to avoid getting an electric shock and contact BT on 0800 111 4567.

## Cleaning

Always unplug your BT TV box (Model DTR-T2100) from the wall socket before cleaning.

Clean the appliance and the mains power supply adaptor only with a soft dry cloth.

Don't use cleaning fluids or solvents. Dust it with a soft damp cloth. Don't use cleaning fluids or solvents. Always unplug your TV box from the wall socket before cleaning.

## Ventilation

Place your TV box (Model DTR-T2100) somewhere that's well ventilated.

Don't cover it or keep it in a confined space (like a cupboard) or stack other electronic equipment on top of it or below it.

Do not cover it and ensure that vents are not blocked.

## Environment

Install the appliance and the power supply adaptor indoors, in a dry, well aired place.

Your BT TV box (Model DTR-T2100) is for indoor use only, in the UK, at room temperatures of 0 – 45°C and between 20 % RH and 90 % RH ambient relative humidity.

Protect the TV box and power supply adaptor from moisture and dust.

Don't put your BT TV box (Model DTR-T2100) or the power supply adaptor on soft furnishings, carpets, delicate surfaces including antique or veneered wood or temperature sensitive surfaces to avoid alteration of colour or cause damage to the surface.

Position your BT TV box (Model DTR-T2100) and all parts, including power supply adaptor away from heat and sun (e.g. away from radiators, windows sill or other electrical equipment which can get hot) and ensure to always avoid extreme temperatures.

Do not place incandescent objects such as candles on or near the appliance and the power supply adaptor.

## Warning

If your box or power adaptor appears damaged, stop using it immediately. If it is safe to do so, switch off and disconnect from the electrical socket, then contact BT on 0800 111 4567.

It's important to avoid damaging the power cord

- Always unplug the power cord by holding the plug (not the cord)
- Only use the power adapter provided with your TV box. Don't change the power cord or plug
- Don't bend or twist the power cord
- Keep the power cord away from heat sources (like a radiator) so the plastic cover doesn't get damaged
- Ensure you have easy access to the mains plug at all times. As a precaution, in case of danger, the mains plug of the power supply adaptor acts as a disconnect device for the 230 V supply
- Keep cables out of young children's reach.

## To avoid electrical shock and risk of fire

Don't open the main body of your BT TV box (Model DTR-T2100) or power adaptor.

Don't insert metal or flammable objects into it. Don't touch the power plug or power adaptor with wet hands.

Unplug it from the electrical socket before connecting (or disconnecting) any cables.

Never squash the power cable by placing objects on top of it, walking or wheeling something over it.

Plugging the power supply adaptor incorrectly may cause intermittent disconnection and may cause a risk of fire or electric shock.

The coaxial connector “Aerial In” of this BT TV box (Model DTR-T2100) is intended to be connected either to an indoor antenna or antenna socket that is fully galvanically isolated (core and shielding) to at least 1.5 kV ~, or an antenna, or an antenna outlet, whose shield of the coaxial cable is imperatively earthed, in accordance with 6.2 (g) and 6.2 (l) of IEC/EN 60728-11 standard concerning the safety of cable distribution networks, and in accordance with the national installation rules.

The Ethernet port is intended to be connected to indoor cable circuits that are exclusively located within the building where the appliance is installed and are not earthed to a different earthing network.

Avoid violent mechanical shocks. Do not use the appliance if it is damaged.

If there is any suspicious noise coming from the mains socket or mains power supply adaptor or cord, unplug the power supply adaptor from the mains socket with all necessary precautions to avoid getting an electric shock and contact BT on 0800 111 4567.

#### **To avoid damaging your TV box**

If your BT TV box (Model DTR-T2100) isn't working properly, stop using it to avoid causing serious damage and contact BT on 0800 111 4567.

Unplug it from the mains socket if there's a thunderstorm.

Only hand-tighten connectors do not use any tools. You are likely to damage the connectors if you tighten them too hard.

When connecting a USB peripheral device, respect the way of insertion and never use force.

#### **To avoid damaging the hard disk drive**

Don't move your BT TV box (Model DTR-T2100) or suddenly turn the power off while the hard disk drive is running. We won't be liable for any corruption of data on the hard disk drive caused by carelessness or misuse.

#### **Radio Equipment Directive Declaration of Conformity**

British Telecommunications Plc declares that the radio equipment type BT TV Box [Model DTR-T2100] complies with Directive 2014/53/EU. You'll find the full text of the EU Declaration of Conformity at [bt.com/tvboxinfo](http://bt.com/tvboxinfo).

#### **BT TV Box Power Consumption and Power Supply Information**

Information can be found at [bt.com/tvboxinfo](http://bt.com/tvboxinfo).

#### **Other information**

##### **YouView**

YouView is subject to terms of use, suitable broadband speed, TV aerial and coverage. See [www.youview.com](http://www.youview.com). Software contained in this device is licensed on a limited basis. All other rights are reserved. YouView and the YouView logo are trademarks of YouView TV Limited and are used under licence. © YouView TV Limited 2010–2020. All logos and content images are trademarks and/or copyright of their respective owners. Images are for illustration only and may differ on screen. Content is subject to availability.

##### **Opensource software**

Your TV box uses open source software. Information can be found at [bt.com/tvboxinfo](http://bt.com/tvboxinfo).

##### **Warranty**

We guarantee your TV box for 12 months from the date you bought it. Subject to the terms listed below, the guarantee covers the replacement of the TV box or any of its components (other than batteries) if we find any are faulty, below standard, not put together well, or put together using unsuitable materials. Replacement is at our discretion. If your TV box is over 28 days old from the date you bought it, we may replace it with a refurbished or repaired product.



#### **Guarantee conditions**

Only defects that occur during the guarantee period are covered. Keep hold of your proof of purchase; you'll need it to claim under the guarantee. You must return the equipment to BT or our agents as instructed. Faults or damage aren't covered if they're caused by accidents, misuse, fair wear and tear, neglect, tampering with the equipment, or any attempt at adjustment or repair other than by a BT approved agent. These conditions don't affect your statutory rights.

Within the 12-month guarantee period If you have problems using your TV box, don't return it before you've spoken to us on 0800 111 4567. If we find it's faulty, we'll tell you how to replace it.

Outside the 12-month guarantee period If you have a problem using your TV box outside the guarantee period, call us on 0800 111 4567 for technical support.

#### **Recycling your TV box**

If you have a BT TV box that you don't need, you can return it for recycling, and we'll pay the postage. Follow the instructions on the return postage leaflet that's inside the pack your TV box came in. If you don't have it anymore, call us on 0800 800 150 and we'll send you a pre-paid postage bag. Sorry, we can only accept BT equipment for recycling.

#### **Recycling electronic equipment**

The TV box, remote control and mini connectors (powerline adaptors) are all classed as electrical or electronic equipment under the Waste Electrical and Electronic Equipment (WEEE) Directive (2002/96/EU). All this equipment should be recycled responsibly to be kinder to the planet. DO NOT put them in your normal rubbish bin. Take them to your local recycling centre for safe disposal. Remember, batteries need to be disposed of responsibly too.





Available in other formats  
including Braille, large print  
and audio CD. Please go to  
[bt.com/mediatypes](https://bt.com/mediatypes)  
or call 0800 800 150.

Offices worldwide

© British Telecommunications plc 2020.

We're registered in England at 81 Newgate Street,  
London EC1A 7AJ, UK (company number 1800000).

See our terms and conditions at [bt.com/terms](https://bt.com/terms)

Item code 077880 | V11 | March 2020