

Get connected

1. Check your Mini Hub's switched on and connected to the network.
2. Go to the network settings of the device you want to connect to the internet. Search for the network name of your mobile wi-fi. (It's written on your password card.)
3. Click connect.
4. Enter your wi-fi password. (It's written on the underside of the battery cover and your password card.)

To read text messages

1. Check your device is connected to your Mini Hub.
2. Enter 192.168.1.1 into your internet browser.
3. Enter your username and password. (These are written on the inside of your Mini Hub's cover.)
4. You're now on your Mini Hub home page. Click on the envelope icon to read text messages.



We'll send texts to let you know about software updates and other changes.

When you have a text waiting, the little envelope icon lights up.

You can also change settings on the home page, including your password and device name.

If you've forgotten your password

Just reset your Mini Hub and you'll be back up and running in no time. Use a paperclip or blunt pin to gently press the reset button.

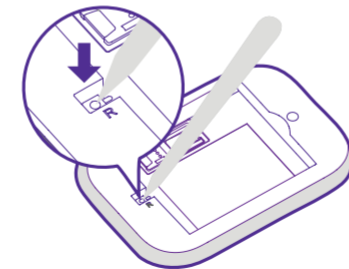

If your hub isn't responding

Hold the power button down for ten seconds and it will reboot.



Need some help?

Have a look through bt.com/help/mobile

Let's get started

Use this short guide to get up and running right away.

You can always visit bt.com/help/userguides to dive into the detail.

If you want to plug your Mini Hub into the wall and use it all week, we recommend removing the battery. Otherwise it might get damaged.

To insert the SIM card

1. Open the back cover.

There's a bit of a trick to this: hold the Mini Hub in one hand and put the tip of your thumb on the other hand into the hole. Pull the cover outwards to open it.

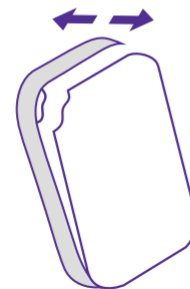

2. Press and push the SIM into the card slot.

For more help setting up, visit bt.com/sim/start

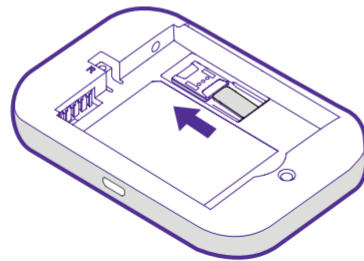

To remove the SIM

Press and hold the flat spring, and then gently pull the SIM card out.

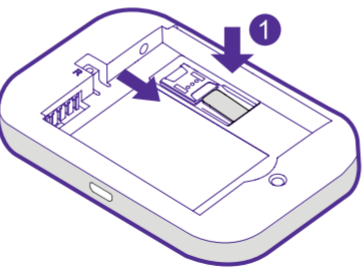

To insert the battery

Match the pins on your battery to the pins in your device. Close the lid so the loopholes line up.

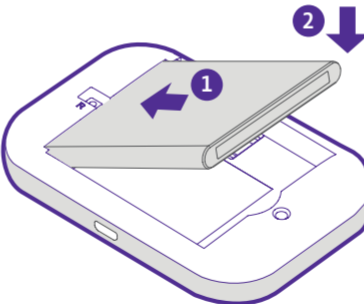

To charge your Mini Hub

Use the Micro USB cable. Or either a 5V/1A or 5V/2A charger.

Once it's charged, you're ready to go. Keep the power button pressed down for a few seconds to turn your Mini Hub on.

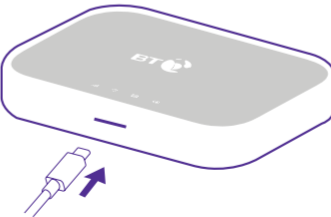

The power indicator will tell you how much battery is left:

- a solid blue light = you have enough power
- a flashing blue light = it's charging
- a solid red light = the battery's lower than 20%

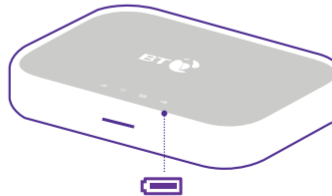

Get to know your Mini Hub

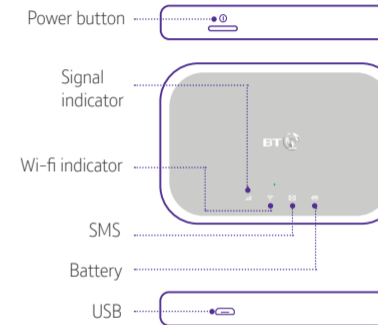

Note: The battery LED will light up when the device is powered on.